



## Smart Meters Rollout in Jordan: Opportunities, Business Models, Challenges, and Recommendations

Ahmed Al-Salaymeh<sup>1\*</sup>, Sara AlTwassi<sup>1</sup>, Rasha AlBeek<sup>1</sup>, Kholoud Hassouneh<sup>2</sup>, Diana Athamneh<sup>3</sup>, Noor Eldin Alkiswani<sup>3</sup>, Rashed Manna<sup>3</sup>, Natalie Asfour<sup>3</sup>

<sup>1</sup>Department of Mechanical Engineering, School of Engineering, The University of Jordan, Amman – 11942, Jordan, <sup>2</sup>Department of Architectural Engineering, School of Arts and Design, The University of Jordan, Amman – 11942, Jordan, <sup>3</sup>EDAMA Association for Energy, Water and Environment, Amman – 11831, Jordan. \*Email: [salaymeh@ju.edu.jo](mailto:salaymeh@ju.edu.jo)

Received: 15 March 2022

Accepted: 01 July 2022

DOI: <https://doi.org/10.32479/ijeeep.13008>

### ABSTRACT

Jordan's energy demand is growing steadily due to many factors ranging from the growing population, to the needed energy for heating, cooling, desalination, and industry (Azzuni et al., 2020). EMRC has stated a new electricity tariff starting from April 2022. The high cost of electricity bill in Jordan with fixed tariff has resulted the need to have a dynamic tariff to transform energy use that lead to demand reductions, a shift in peak demand, a better management of distribution networks, in addition to reductions in operation costs. A full transition towards smart meters in Jordan is one of the main pillars to achieve a compatible smart grid system that will be a great solution to sustain the energy security. Also, it will lead to flatness the demand profile which will have economic consequences by reducing the cost of electricity generation. The current status of smart meters' rollout, the optimal business model, challenges, and awareness towards energy strategies and smart meters deployment in Jordan have been investigated. It has been found that the optimal business model for the Jordanian market is a hybrid model of DGC and EaaS models. Also, a set of opportunities and recommendations have been concluded.

**Keywords:** Smart Meters, Business Models, Dynamic Tariff

**JEL Classifications:** O3, O5

### 1. INTRODUCTION

The increasing of economic challenges, growing population, and rising standards of living have makes energy security a top priority for governments across the world. Securing energy is particularly challenging for Jordan, which suffers from scarcity of natural resources, combined with the regional instability and conflicts, e.g. Sandri et al. (2020).

The Jordanian Energy Sector Strategy's (ESS) main challenges for the years from 2020-2030 is achieving the security of sustainable energy supply and optimum utilization of natural resources. Consequently, the ESS aims to increase the contribution of local energy sources to electricity generation from 15% in 2019 to 48.5%

in 2030. The main local contributors are the renewable energy (its contribution will reach 31% in 2030) and oil shales (its contribution 15%) (MEMR, 2019). Therefore, the domestic demand for energy is increasing at a sustained pace and the country imports around 89% of its energy supply (MEMR, 2021). The goal is to provide reliable and affordable electricity from locally available resources, such as renewable energy sources. Energy security has social, political, economic, and environmental implications. Consumption patterns need to be addressed too, taking into consideration price distortions and socio-economic implications (Sandri et al., 2020). Jordan suffers from the high cost of the energy bill, especially after the Gulf War (2003) and energy cost reached after some years 20% of Jordanian GDP. During the Arab Spring, the Egyptian-Jordanian Gas Pipeline was sabotaged and blown-up more than 10 times

causing interruptions to the natural gas flow that supplies more than 80% of the electricity thermal power plants and resulting in economic losses of more than 7 billion US Dollars. The National Electric Power Company (NEPCO) is still suffering from the consequences of that huge loss and resulting debt. The high cost of energy bill forced the Jordanian government to remove the fuel subsidy and increase fuel and electricity prices. That has led the government to find alternative local energy sources such as solar and wind energy. Then the renewable energy law was issued in 2012 by the government and the deployment of Renewable Energy (RE) in electricity generation has reached 20% in 2021. Also, NEPCO diversified energy resources for energy generation purposes by importing Liquefied Natural Gas (LNG), Natural gas from Egypt, Nobel gas from Mediterranean region, in addition to increasing the local electricity resources from renewable energy and oil shale.

As a result, the main problem for the energy sector in Jordan is the high cost of electricity bill which has a fixed tariff (not related to time of use). There is a need to have a dynamic tariff to transform energy use that lead to demand reductions, a shift in peak demand, a better management of distribution networks, in addition to reductions in operation costs. Therefore, installing of smart meters will pave the road to adopt the electricity dynamic tariff.

The smart meters are meant to enable variable tariff depending on the time of use; such a tariff system will directly impact the pricing to the final user, the economics of the energy market. It also, has social effects in regards to the consumption patterns, awareness and further engagement with the billing system, and improve the infrastructure toward a smart grid. The national by laws and regulations shall be examined to apply smart metering along with expansion planning.

A full transition towards smart meters in Jordan is one of the main pillars to achieve a compatible smart grid system that will be a great solution to sustain the energy security in the country. Also, it will lead to flatness the demand profile which will have economic consequences by reducing the cost of electricity generation.

Smart meters have the potential to bring benefits to consumers in terms of reduced energy bills through a more efficient (and hence cheaper to run) energy system and through reduced energy consumption, stimulated by improved information about energy usage. In addition, it will reduce the operational running cost on the distribution electrical companies, such as: removing the need for site visits from suppliers to read meters. Electric companies can use smart meter data to monitor the health of the energy grid, restore electric service more quickly when outages occur, integrate distributed energy resources, and deliver energy services and solutions to customers.

The current paper aims to answer the following overarching research questions: how can smart meters' transition in Jordan contribute towards economic wellbeing, economic development, help reduce cost, adopt dynamic tariff, deployment of smart grid, increase the share of Renewable Energy (RE), better

management of distribution networks, and a sustainable energy security sector.

Much of the debate around the progress of the rollout to date has focused on technical issues. However, there are a number of socio-economic issues related to have the potential to help or hinder the rollout. To accelerate the deployment of smart meters, it is important that these aspects receive greater attention. In this paper, the main opportunities, challenges, and recommendations for the smart meters' transition in Jordan have been highlighted by taking into consideration the following key areas; proposed tariff with the roll out of smart meters, promoting energy saving due to using smart meters, economic development, cost-effectiveness, and life cycle of smart meters.

## 2. BACKGROUND

In response to Jordan's Energy Sector Strategy's (ESS) action plan for 2020-2030 that set a target of full transition towards smart meters by 2022, this research paper will support the transition towards smart meters and will promote potential businesses for private sector. Also, it aims to standardize smart meters that will support the renewable energy transition by opening the door for smart grid innovative solutions. This could be achieved post smart metering transition such as battery storage before meters and smart grids etc. Therefore, a research has been implemented to identify the smart meters' rollout current status internationally, regionally, and locally in Jordan.

### 2.1. International Smart Meters Rollout

Over the last two decades, a number of countries have installed millions of smart meters to improve the efficiency, reliability, and quality of service in the electric power sector. Compared with traditional meters, smart meters measure consumers' electricity usage on 5 or 15-minute intervals. Then, they communicate that usage and other data automatically to the utility. Both electricity consumers and their utility can benefit from Smart Meters: they provide more information to manage electricity consumption, improve power outage detection and restoration, enhance opportunities for additional value-added services such as billing options and time of use rates, lower the utility's costs, and enable distributed energy resources like solar and storage. Figure 1 shows the smart meter rollout period for selected utilities, states, and countries. As is evident from this figure, the set targets for smart meter installations were achieved over four years or more in most cases, e.g. KAPSARC (2021). A new study has released by Berg Insight has found that "more than half of electricity meters in Europe are now smart", and the installed base rate is expected to increase by 7.2% annually till 2026, e.g. Renewable Energy World (2021).

#### 2.1.1. USA experience

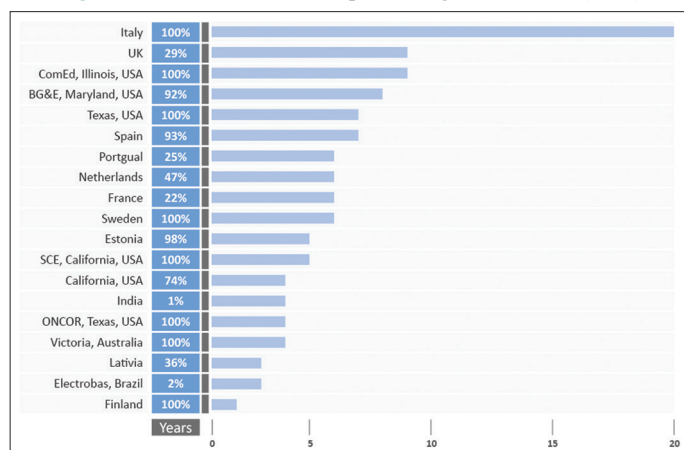
Deployment of smart meters in USA began more than a decade ago. Today, electric companies continue to work with technology companies to utilize the data and capabilities that smart meters provide to benefit customers. In fact, throughout 2020, many electric companies used smart meter data to deliver personalized energy management insights and tips to assist customers during the COVID-19 pandemic.

Smart Meter installations have increased dramatically since 2011. As Figure 2 shows of year-end 2019, electric companies had installed 99 million smart meters. While 107 million smart meters were deployed by year-end 2020, covering 75% of U.S. households, and that 115 million smart meter deployments are expected by year-end 2021, e.g. Edison Foundation (2021).

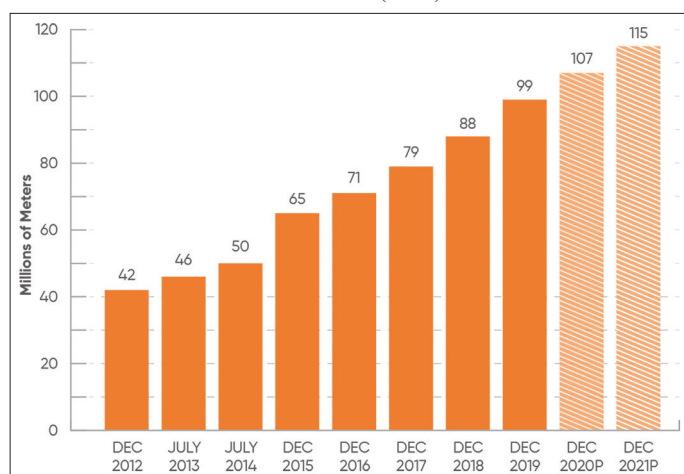
Smart Meters are among the technologies electric companies are using to engage customers with energy management, and demand response programs that encourage them to shift their electricity usage away from peak demand times. As the number of connected home/building devices like smart thermostats continues to grow, customers have more opportunities to save energy and money while reducing carbon emissions.

As the impacts of COVID-19 persist, residential customers are spending more time at home and hence are using more electricity. Throughout this pandemic, electric companies have supported their customers by offering innovative customer assistance, bill relief programs and flexible customer payment plans. They also are providing proactive communications to engage customers in energy management and helping to accelerate the delivery of energy assistance funds.

**Figure 1:** Smart meter rollout period, e.g. KAPSARC (2021)



**Figure 2:** U.S. Smart Meter installations reach 107 million in 2020 and are projected to reach 115 Million in 2021, e.g. Edison Foundation (2021)



### 2.1.2. Australia experience

The Australian market has been slower to adopt the technology. However, that is now starting to change. There is new growth in smart metering solutions as more homes adopt solar and other behind the meter solutions. While, the New Zealand market has now reached about 90% smart meter penetration, which is a result in improvements to market competition and the economic benefits to both the consumer and the retailer by unlocking smart meter services at scale, e.g. Smart Energy International (2021).

The smart meters' transition is led by an Australian and New Zealand based utility services company. It delivers innovative metering and data solutions to maximize digital and new energy services. The company states that solar or other behind the meter services was the motivation for almost two-thirds of its new smart meter installations in 2020. Other drivers are new or renovated homes and commercial premises that are connecting to the electricity grid and the replacement of old meters either failing or on request from customers via their electricity retailer.

The Australian government as estimating that one in four Australian homes now have solar PV installed, with an installation rate 10 times faster than the global average. Installations in January 2021 were 23% up on the same month in 2020, (Smart Energy International, 2021).

### 2.1.3. Dubai experience

In total, Dubai Electricity and Water Authority (DEWA) replaced almost 800,000 smart meters in record time. The Utility (DEWA) was able to improve the availability of meters' readings by reaching a total of 99.1% in 2020. This covered the whole Emirate of Dubai, and replacing all mechanical and electromechanical meters.

In 2020, Dubai's DEWA Company has successfully connected over 2 million smart meters to the electricity and water supply networks. The company's total investment is estimated to reach over 1.9 billion US dollars by 2035. The project is part of the Emirate's efforts to develop smart grids.

The smart meters are the core component of the smart grid. They collect and analyze real-time data about consumption patterns. As part of its continuous efforts to improve the efficiency of its operations, DEWA is also developing smart grids, e.g. DEWA (2020).

### 2.1.4. Saudi Arabia experience

In 2020, the Saudi Arabia's Smart Metering Program started with a target of 10 million meters. Despite the challenges of the COVID-19 epidemic, smart metering was able to be successfully replaced with 10 million analogue meters in less than 13 months by Saudi Electricity Company (SEC), as Saudi Arabia commenced a target for 10 million meters as part of its Smart Metering Program in February 2020, to be completed by March 2021. Also, 4 million of the 10 million units, that were installed in Saudi Arabia, were locally made. This is part of the country's efforts to reduce its dependence on importing technology. Installing 10 million smart meters in such a short time is indeed a commendable effort. Despite the challenges of Covid-19, the SEC managed to install ~126,000

smart meters in a single day, a world record, beating China's record of ~104,000 per day, e.g. KAPSARC (2021). Also, China Electric Power Equipment and Technology (CET) had deployed its Mobile Workforce Management and Advanced Network Deployment solution to help with the installation of 10 million smart meters for Saudi Electric Co., e.g. Smart Energy International (2021).

In Figure 3, the bars represent the average per day smart meter rollout when normalized with respect to the customer base of ~10 million in Saudi Arabia, e.g. KAPSARC, 2021.

## 2.2. Jordan Smart Meters Rollout

Jordan Energy Sector Strategy (ESS) action plan for 2020-2030 aims to install smart meters within the next three years -of ESS establishment-. 30% by 2020 and 30% by 2021, and 40% by 2022. However, this is to be delayed due to the COVID-19 ramifications and the lack of funds. On the other hand, further studies on the smart meters' feasibility, ensure infrastructure resilience and increase the people awareness regarding the replacement of old meters with new Smart Meters with many additional features and different billing system capability are needed.

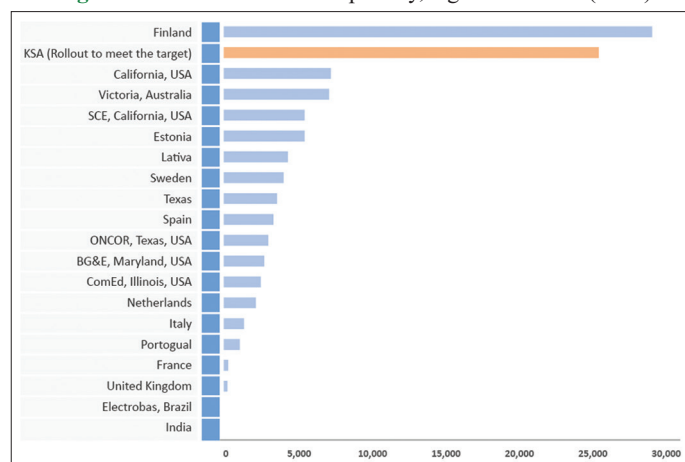
The transition towards smart metering still need the funds and the technical studies to address such a change on the operators, distribution companies, the final user prices and investigate the expected impact on the load profile and the grid flexibility. Also, there is a lack of both technical and evaluation studies in order to apply smart metering in Jordan and developing countries in general.

### 2.2.1. Current status of smart meters in Jordan

The electricity sector in Jordan has three separate entities in generation, distribution and transmission –as shown in Figure 4:

- Generation Sector including Central Electricity Generation Company (CEGCO), Samra Electricity Power Company (SEPCO), Amman East Power Company, Qatrana Power Company and Independent Power Producers (IPPs).
- Transmission Sector including National Electric Power Company (NEPCO).
- Distribution Sector including Jordan Electric Power Company (JEPSCO), Irbid District Distribution Company (IDECO) and Electricity Distribution Company (EDCO).

**Figure 3:** Smart meter rollout per day, e.g. KAPSARC (2021)



The deployment of Smart Meters in electrical companies in Jordan needs policies and regulations to be adopted. Currently, the smart meters' deployment in Jordan is through the distribution sector companies (JEPSCO, IDECO, and EDCO).

While taking into consideration, that the transmission sector (NEPCO) already utilized Smart Meters for more than ten years. Therefore, the following sections describe its deployment in each electrical sector.

#### a) Generation Sector

The smart meters are used in the generation power plant for measuring the imported/exported power to their single customer (NEPCO). Usually, each generation unit has two advanced meters (main and check).

As an example of power generation sector companies, SEPCO is a power generation company that owns Samra Power Plant with a total capacity of 1241 MW. Also, SEPCO is fully deploying smart meters in its power plant with a total number of 22 smart meters.

The tariffs are set with the Energy and Minerals Regulatory Commission (EMRC) based on the fixed capacity charge model linked with the generation unit's availability. The plant meters are supplied, installed and calibrated by NEPCO.

#### b) Transmission Sector – NEPCO

The need for the transition towards smart meters in NEPCO (as it is the only company in the electrical transmission sector in Jordan) has resulted from the high transmission of electricity from the generation sector to NEPCO and then from NEPCO to the distribution sector.

The study for adopting smart meters at NEPCO started in 2007, and the first deployment was in 2010. It was applied to 7 stations that used Automatic Meter Reading (AMR) technology. In 2015, NEPCO has fully transitioned its meters to smart meters with a total number of 800 smart meters (till end of 2021) connected to the feeders and adapters. Their infrastructure can cover up to 5000 meters.

In 2021, the applied software in NEPCO is Meter Data Management (MDM) and only one station is applying GPRS. The MDM software is collecting data (power, voltages, current, etc.) by two load profiles; one of the profiles is updated every 30 minutes and the other profile is customized. NEPCO offers for the large consumers a flexibility in tariffs; day, night, and maximum load.

#### c) Distribution Sector – JEPSCO

Jordan Electric Power Company (JEPSCO) carried out a trial phase of developing the current meters and upgrading to smart meters' infrastructure. The company continued its efforts to expand the pilot projects that it had previously launched with the aim of building the smart meter system. This is done by installing more meters so that the number of smart meters by the end of 2021 reached (140,947) meters working on different communication systems as shown in Table 1, e.g. JEPSCO (2022).



Figure 4: Current structure of the electricity sector

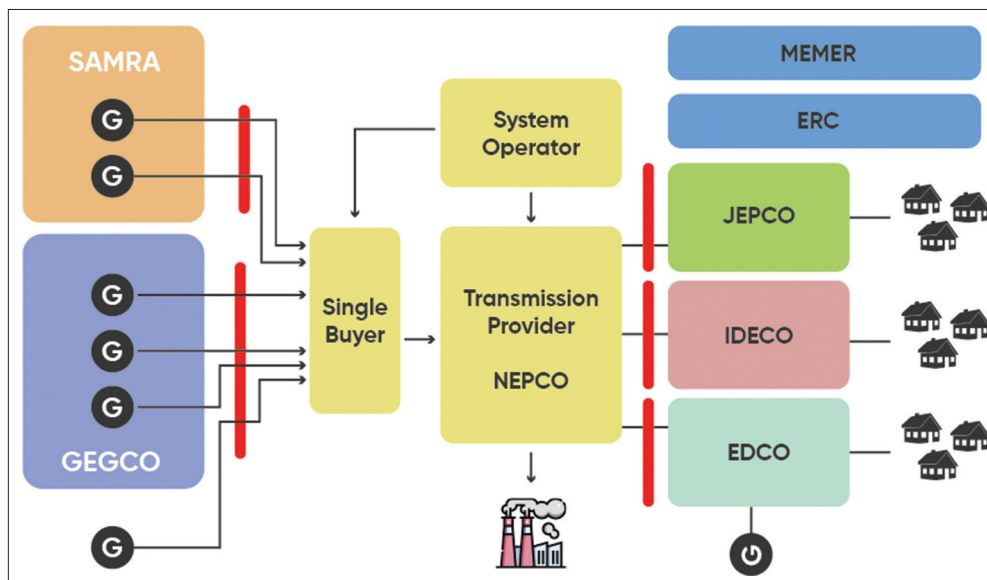


Table 1: Smart meter types at JEPKO with their total numbers

Meter type	Number of installed smart meters
Single Phase Meters – Direct	111,495
Three-phase Meters – Direct	22,700
Three-phase meters - current transformers (large consumers)	5,096
Three-phase meters - current and voltage transformers (large consumers)	1,656
Total	140,947

By the end of 2021, the company has a total number of 1,518,892 meters and 140,947 meters are smart, which leads to a total deployment of approximately 9.3% of smart meters in JEPKO. Also, it is expected to reach more than 210,000 smart meters by 2022.

– IDECO

The deployment of smart meters’ project in IDECO was based on extensive tests and garnered experience; IDECO has tested different small projects to identify the suitable communication method that will guarantee a successful connection from the meter to IDECO servers including GPRS, PLC, RF and mesh networks. The PLC method was unsuccessful due to extreme noise in low voltage network which is caused by load types and renewable power sources like PV.

Radio Frequency (RF) faced restrictions from the Telecommunications Regulatory Commission (TRC) due to certain communication laws and regulations. The main concern of using RF is data security. As there is a high possibility to face data interference which is caused by transmitters on the same or similar frequency to the one you’re receiving. Consequently, using any smart device based on RF technology is prohibited by the Jordanian communication law and regulations.

Accordingly, in 2016 IDECO started with installing (500) single phase meters and (300) three phase meter that has a plug-and-play GPRS modems in which IDECO installed cellular SIM’s

from local Internet Service Provider (ISP) with 1GB bundle. These meters were connected to a local server on which they had installed the AMI system.

In 2019 and 2020, IDECO began ordering all quantities of meters to be smart along with communication channels for 5+ years. These tenders were awarded to local ISP’s here in Jordan (Zain and Orange).

In the third quarter of 2021, the total number of meters in IDECO is 600,000; 55,322 of them are smart meters. This means that the deployment of smart meters at IDECO is 9.22%. By the end of 2021, a total of 68,865 smart meters are installed and it is expected to deploy new 35,000 smart meters in 2022.

The growth of the smart meters’ project was huge in terms of their quantity and in terms of IT development. This growth caused some load on IDECO’s IT resources (hardware and manpower), so they decided to migrate their systems to local cloud services. They are currently in the process of rebuilding their systems on Orange Cloud in preparation to this big move.

– EDCO

EDCO has worked on supplying single and three -phase smart meters during the year 2020. The number of smart meters operating in EDCO of various types reached (33210) meters, which are connected by (GPRS) communication method with the remote reading and control system from (Huawei & Hexing) company. All the meters supplied to EDCO are now of the smart type, and the following has been accomplished during the year 2020, e.g. EDCO (2020).

1. The installation of (12,500) smart meters was mostly for new customers. However, it was affected by the COVID-19 pandemic
2. Installation and replacement of (2000) three-phase smart meter
3. Issuing a new supply order for the supply of (12,000) single-phase meters

4. Signing a new agreement with Orange Company to supply smart meters from Chinese company (Holley) for a period of two years, equipped with GPRS communication modems.
5. Supplying, installing and operating a remote reading and control system from Hexing.
6. Adding (6,500) meters to the smart meter system currently operating in the company (Huawei HES system), as the system connected to about (15,000) (single and three-phase meters using GPRS and PLC).

In the third quarter of 2021, EDCO has reached a total number of 265,000 meters as 48,000 meters are smart kind. Which means that the deployment of smart meters in EDCO has reached 18.1%. EDCO is deploying 56,000 smart meters by the end of 2021 and it is expecting to have new 38,000 smart meters by 2022.

### 2.2.2. Electricity policies and regulations in Jordan

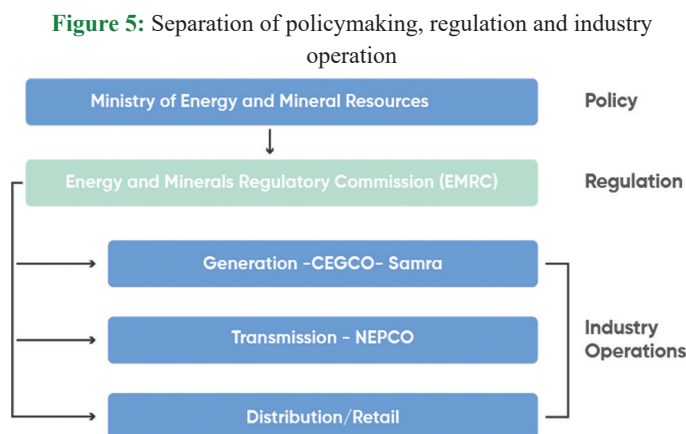
As shown in Figure 5, there is a separation of policymaking, regulation and industry operation in the electricity sector. As the Ministry of Energy and Mineral Resources (MEMR) defines the energy policies by:

- Set and prepare the general policies of the sector
- Cooperation with other countries
- Promote the use of renewable energy for generation
- Recommend Council of Ministers to advance to a more competitive electricity market

On the other hand, the Energy and Minerals Regulatory Commission (EMRC) regulate the electricity sector by:

- Issue Licenses: Generation, Transmission, Distribution, System operation and Bulk Supply
- Issue sector regulation (code, orders, and directives)
- Determine electricity tariffs and connection charges
- Participate in technical and environmental standards
- Recommendations (to the Ministry) to advance to a more competitive electricity market

In 2021, EMRC has published a unified specifications and regulations for the smart meters' transition among the electrical distribution companies in Jordan.



## 3. METHODOLOGY

This research paper aims to study the smart meters' rollout in Jordan in regards to its: current status, challenges, opportunities, the optimal business model, and awareness towards Energy Strategies and smart meters' deployment in Jordan.

The methodology progress –as shown in Figure 6 started with preparing a business network by pointing out a list of potential stakeholders from energy sector (private and public) in Jordan as shown in Figure 7. Therefore, an examination of the worldwide Smart Meter's Business Models (BMs) has been conducted in order to adopt the valid and most up to standard BM. Consequently, the suggested BMs have been analyzed in terms of strengths, weaknesses, opportunities, and threats (SWOT analysis). A survey has been circulated to the energy sector stakeholders, policy makers, and experts. Also, interviews with key stakeholders have been carried out. The results and recommendations that should promote integrity and complementarity among stakeholders are highlighting the optimal business model for the Jordanian context. As a result, a list of recommendations has been developed to assess the transition towards smart metering in Jordan.

The data collection methodology of this work is based on the literature review, large-scale survey and interviews with energy sector stakeholders (as shown in Figure 7). The main data gathering instrument was a survey which was developed based on the background review of the literature on Energy Sector Strategy (2020-2030), International smart meters rollout, and Jordan smart meters' rollout. The survey was based on the interview protocol with multiple-choice questions. The interview protocol also included ranking questions to identify various preferences. The interview protocol included separate questions for energy sector strategy and smart meters' transition in Jordan with its best fit business model.

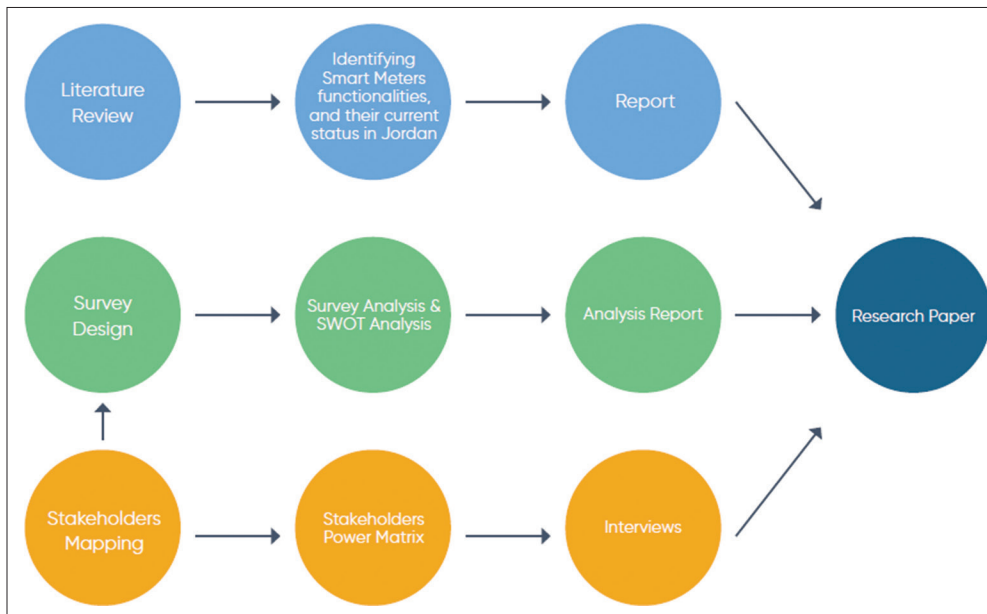
Figure 7 represents stakeholders' power/interest matrix that categorizing stakeholders from energy sector in Jordan. A stakeholders' analysis has been carried out by identifying, mapping, as well as, prioritizing stakeholders through power/interest matrix. The main categories that were considered in the stakeholders mapping are the following:

1. Governmental Organizations (Ministries)
2. Electricity sector with its different categories (generation, transmission, distribution)
3. Information Technology Companies (ICT)
4. Commercial Companies operating in the sector for supply, installation, and implementation
5. Consultancy offices
6. Contractors

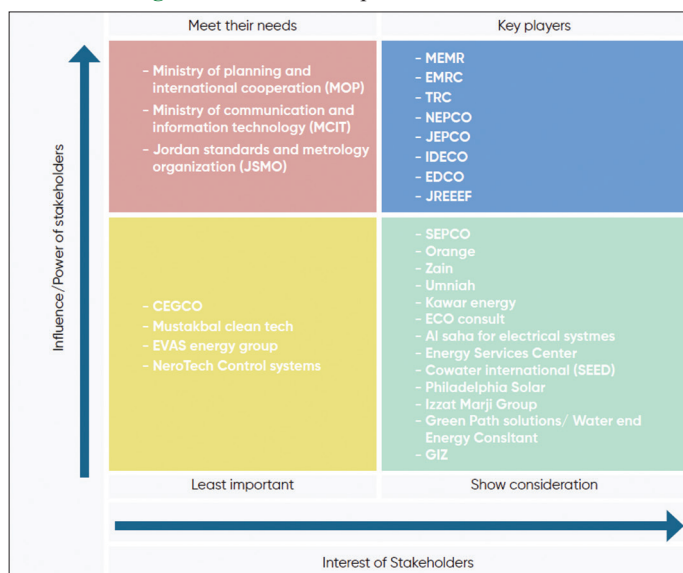
## 4. RESULTS

The results of this paper are based on wide-scale survey and interviews with stakeholders from energy sector to define the knowledge of respondents (stakeholders and decision makers) about Energy Sector Strategy (ESS) action plan for 2020-2030, smart meters' deployment in Jordan, and collect feedback from the stakeholders on their vision for the most suitable business

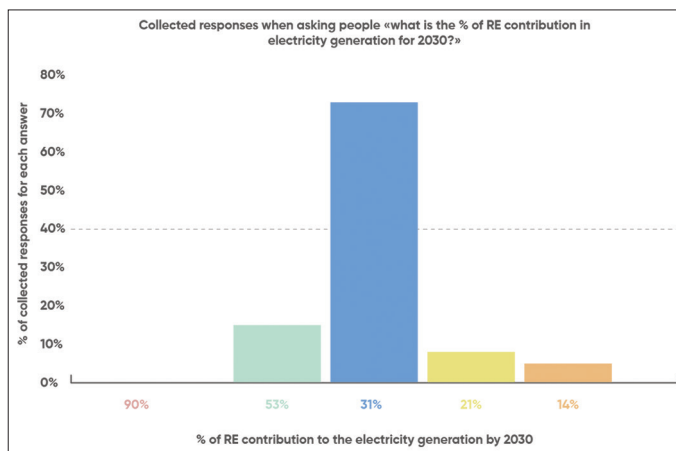
**Figure 6:** Research methodology



**Figure 7:** Stakeholders power/interest matrix



**Figure 8:** Percentage of the contribution of renewable energy to the electricity generation by 2030



model for Jordan, taking into consideration the economic growth in the future.

**4.1. Awareness of the Energy Sector Strategy (ESS) for the Years 2020-2030**

The awareness of the main axes of the ESS for the years 2020-2030 is very high (81% of all surveyed people are well acquainted). Almost half of the surveyed people are aware of the strategic and national goals of the ESS, and it can be noticed that they are well recognized to the differences between them. In addition, it is interesting that the energy sector stakeholders are knowledgeable and well noted about the optimal scenario for the ESS for the years 2020-2030 (which is: increase self-reliance).

In addition, as shown in Figures 8 and 9 the results show high level of realization (73%) to the renewable energy (RE) contribution that is assumed to be reached 31% to the electricity

generation by 2030. The high awareness among surveyed people towards RE contribution in the energy sector (especially its’ contribution to the electricity generation and energy mix) might be connected to the fact that there is a massive information campaign about increasing the dependency on green energy resources in Jordan especially the renewable energy (RE). While surprisingly, quite the opposite when asked the surveyed people about the percentage of oil shale’s contribution to electricity generation from 2020 to 2030, as most of the surveyed people (72%) are not aware that the percentage of its contribution will stay the same in 2030.

On the other hand, while talking about smart meters in ESS, most of the surveyed people (as shown in Figure 10) think that the strategy target to have a full transition towards smart meters by 2030 (while it was stated by 2022), which reflects low awareness of the smart meters transition plan, as shown in Figure 11. That’s might be due to the intangible transition and low rates of smart meters’ deployment in Jordan till now.

### 4.2. Smart Meters Deployment in Jordan

The survey results show that there is a very high awareness of the smart meters' transition in Jordan, as seen in Figure 12, (84%) of the surveyed people are aware of the smart meters' projects in Jordan. In addition, high rate of social acceptance and support towards smart meters is present in Jordan.

Surprisingly, a very high percentage of the surveyed people are not aware of the current status of smart meters' deployment in Jordan. For example, people believes that the transition of smart meters in the southern part of Jordan has not started yet, whereas the situation

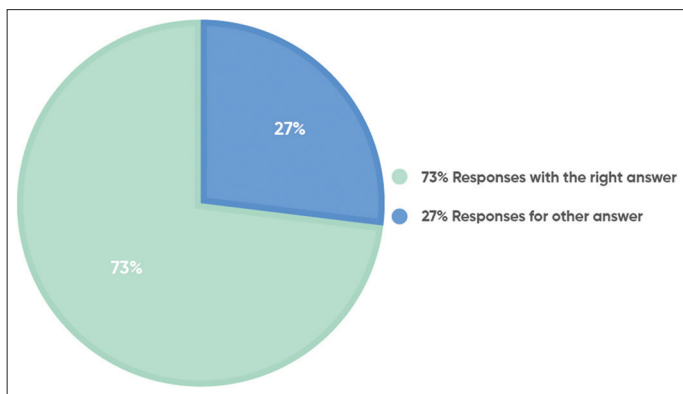
is that the highest percentages of smart meters' deployment is in EDCO (Electrical Distribution Company for the southern part of Jordan and Jordan Valley).

Although smart meters' transition has a high social acceptance but at the same time people are not ready to pay the value of smart meter's installation, as shown in Figure 13. Most of the surveyed people see that it's the role of the distribution companies and funding agencies to cover the cost of installment. Nevertheless, high share of people (60%) would installing the value of the smart meter on their electricity bill in exchange for providing them with data of their electricity consumption on their cell phones.

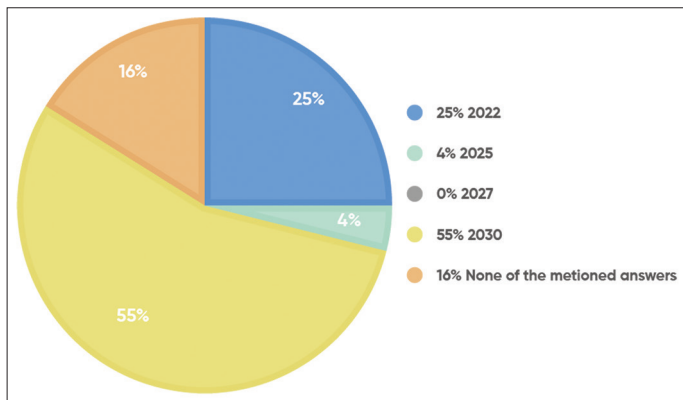
Data of the current research show that people still prefer to pay by bills (based on their monthly consumption) even after the transition towards smart meters and that's due to that they get used to it as a payment method, as shown in Figure 14. Also, Figure 15 shows that most of people prefer to pay their bills online. Many people prefer to be contacted by the electricity suppliers through software applications (for ex: WhatsApp). Where others prefer SMS as an appropriate way to be contacted by the electricity supplier.

The amount of energy consumed and the total amount of money owed are the most checked information in electricity bills by costumers. Therefore, people have reflected a very high interest in obtaining information on the distribution of electricity consumption by type of home appliance, in addition to get a service to analyze their energy consumption, with relevant suggestions to decrease consumption. Nevertheless, many people are not willing to pay for energy consumption analysis services, while others are willing to pay just in case it is a once time payment with a maximum amount of 10 JOD/year, as shown in Figure 16.

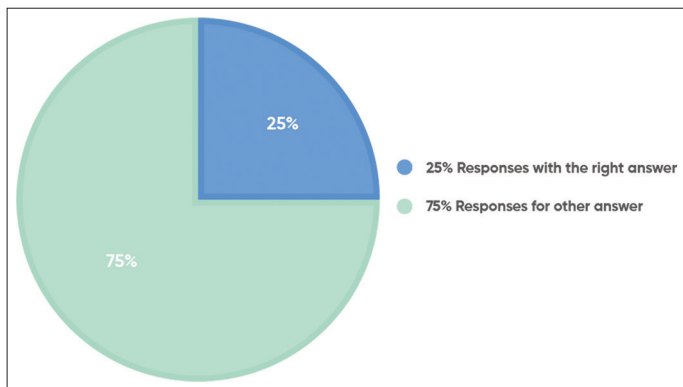
**Figure 9:** Awareness Scale based on the collected responses in Figure 8



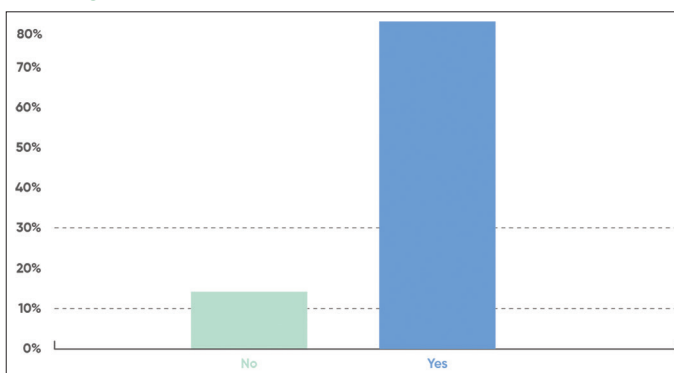
**Figure 10:** According to the strategy, When will be the 100% full transition towards smart metering systems?



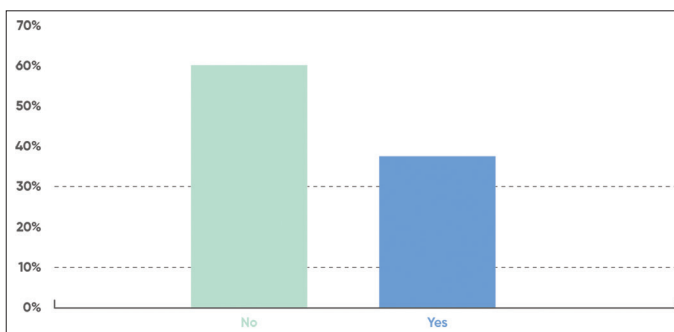
**Figure 11:** Awareness Scale based on the collected responses in Figure 10



**Figure 12:** Awareness of smart meters transition in Jordan

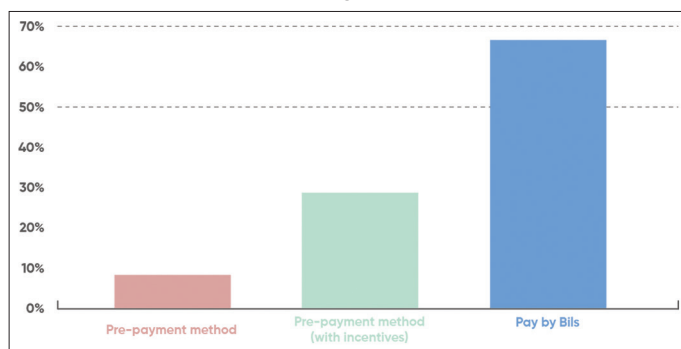


**Figure 13:** Willingly to pay the cost of installing a smart meter

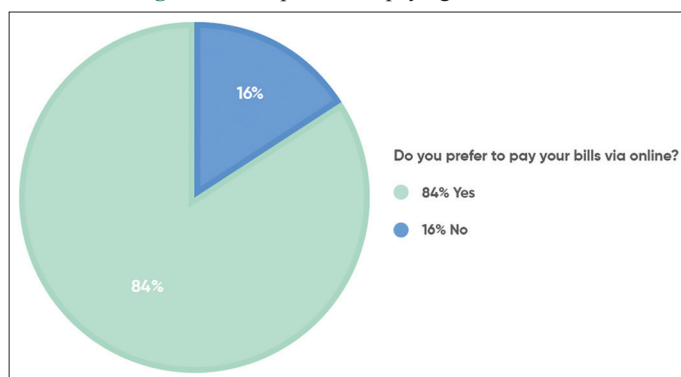




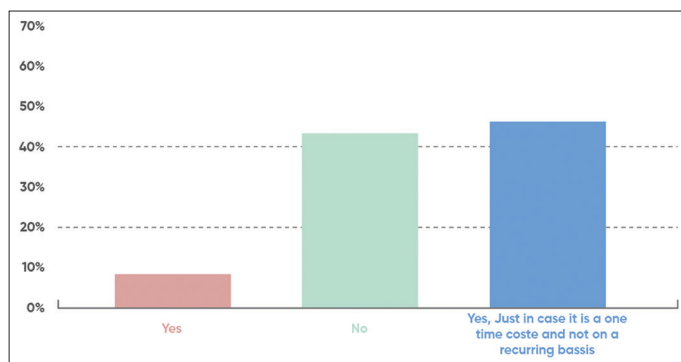
**Figure 14:** Preferred payment method for the electric consumption after installing smart meters



**Figure 15:** Responses for paying bills online



**Figure 16:** Willingness to pay for energy consumption analysis services



People have shown their ability to accept turning on or off certain devices in special cases due to the needs of the distributor if they receive a discount on their invoices. The dishwasher machine was the most home appliance that people accept to turn it on/off depends on the needs of the distributor, where only a few people accept to limit the use of their computers.

The most information that people would like to know more if they install a smart meter are: how to use less energy in their home by changing their habits and routine, and what changes they can make to their home to make it more energy efficient.

Dynamic tariff received a very high support by people (75%) and they believe that smart meters will help to have a dynamic tariff.

Most of them support to have a dynamic tariff at the peak hours or day and night tariff. While speaking on tariff, the surveyed people (70%) have already check the new set tariff by the government and understood it well. The majority of people believes that the new tariff that was set by the government will increase the demand for the installation of smart meters in Jordan as they see that the price of electricity tariff in Jordan compared to neighboring countries is very high.

### 4.3. Smart Meters Business Models (BMs)

The increased deployment of distributed energy resources along with the widespread availability of smart meters has created room for innovative business models. Three suggested business models were presented to the surveyed people:

1. A metering company (MC) – is a brand new market player established to meet the metering service's needs. Smart meters are on the balance of the Metering Company. One Metering company can provide its services for the whole range of utilities: electricity, water, gas and heat supply. Thus, the synergetic effect is reached through the lowering of investment costs for utilities. A metering company is able to cover the country with only one zone. Either DGC or a metering company can be responsible for meters' operation and ownership. The example of such a company is the UK DCC.
2. Distribution Grid Company (DGC) is an owner of smart meter and it performs the metering infrastructure control and it provides metering services. This model is best matched to the current market structure of Russia and meets the least industry resistance during smart meter installation. The smart meter deployment can be performed with fewer resources and work processes. It is also possible a creation of doubling communication networks for gas, heat and water industries that will lead to an increase of investment cost.
3. Energy as a service (EaaS) performs the metering function on liberalized market using existing agreement relations with the customer. In this case, a smart meter will not be perceived as part of the distribution grid. EaaS model has been implemented in Australia, China, Finland, Ireland, Italy, Japan, Sweden, UK, and US.

People were asked to evaluate the three suggested business models (BMs) to be applied in Jordan by taking into consideration the economic growth. The highest supported BM is DGC business model then MC & EaaS.

#### 4.3.1. (MC) Business Model

Many people are positive in their expectation for this BM as they think that the cost of establishing a private company for smart meters is compatible with the need for a complete transition of smart meters in Jordan. Nevertheless, the majority of people (63%) believe that the time required to set up a private smart meter company will delay the full transition of smart meters by the end of 2022.

On the other hand, when people were asked if that a private company for smart meters' business model will provide the best services compared to other models, it has been resulted that the

supported percentage was the least compared to the other BMs. In addition, people were between opponents and supporters when they were asked if they think that having a private company for smart meters will affect the data privacy of consumers. Also, people are not expecting positive effects on energy efficiency when applying this BM. This frequency in answers, might be due to the non-previous experience with such a business model.

Lastly, people believe that the Energy & Minerals Regulatory Commission (EMRC) is the supervisory body that must monitor the work of the private company for smart meters.

#### 4.3.2. (DGC) Business Model

People are most positive in their expectations in this business model, and that can be due to that most of the surveyed people (60%) believe that the electricity distribution companies have an infrastructure compatible with the complete transformation of smart meters. In addition, they believe that the adoption of smart meters by electricity distribution companies will be in line with the future economic growth in Jordan. Nevertheless, and as the case of other business models, the majority of the surveyed people (70%) believe that the electricity distribution companies will not completely convert their meters to smart meters by the end of 2022.

This BM received the highest percentage of acceptance by people as most of them (72%) believe that the adoption of smart meters by electricity distribution companies will provide the best services compared to other models. Another sign that people are supporters to this BM, most of them (63%) believe it will not affect the data privacy of consumers. In contrast to the first BM, this BM got a high positive reaction (74%) that it will positively affects energy efficiency.

Lastly, as the previous BM, people believe that the Energy & Minerals Regulatory Commission (EMRC) is the supervisory body that must monitor the work of the distribution companies for smart meters.

#### 4.3.3. (EaaS) Business Model

It seems that people are not very optimistic towards this BM, as the majority of surveyed people (61%) see that smart meter service providers don't have an infrastructure compatible with the complete transformation of smart meters. Also, people were between opponents and supporters when they were asked if they think that this BM will be compatible with the future economic growth in Jordan. Regarding the full transition towards smart meters by 2022, as the case of the previous BMs people are not optimistic (67%) that this BM will achieve it.

Nevertheless, a high percentage of the surveyed people (62%) believe that the smart meter service providers will provide the best services compared to other models. People are also optimistic and supporters to this BM in regards to the data privacy of consumers as most of them (63%) believe it will not affect the data privacy of consumers.

Lastly, as the previous BMs, people believe that the Energy & Minerals Regulatory Commission (EMRC) is the supervisory body that must monitor the work of this BM.

## 4.4. BMs SWOT Analysis

In Figures 17-19 SWOT analysis has been performed to define the Strength, Weaknesses, Opportunities, and Threats for the suggested smart metering business models depending on the survey results. This will lead to select the optimal BM for the Jordanian context.

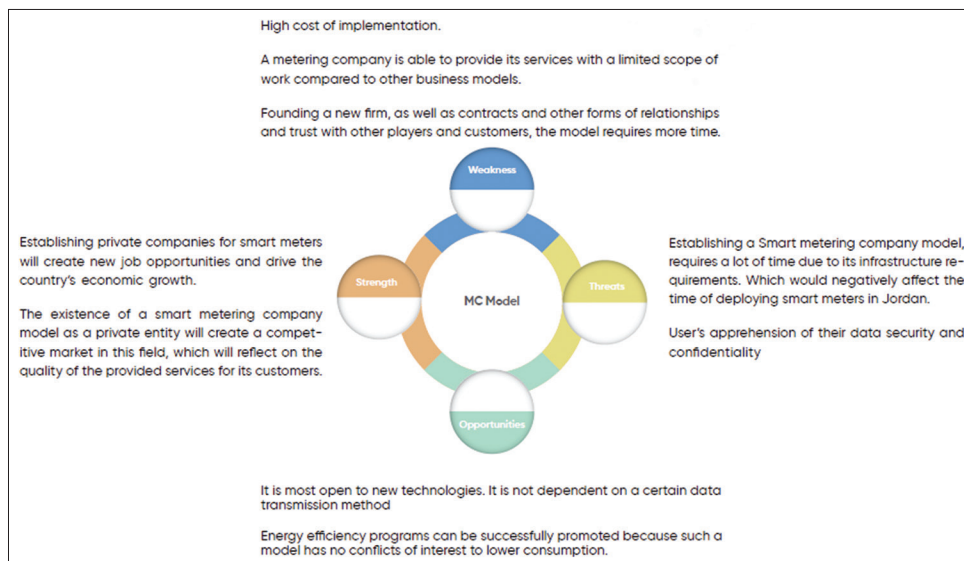
It has been found that the highest strength was assigned to the DGC model, as electricity distribution companies have an existing infrastructure compatible with the complete transition to smart meters, which will save time, money, and efforts. The MC model, however, has shown some weaknesses due to the time required to set up a private smart meter company, posing delay to the full transition to smart meters by the end of 2022. Meanwhile, the EaaS model holds opportunities to the IT market and paves the way for the Internet of Things (IoT) and Artificial Intelligence (AI). The main threat across all business models is the delay in transitioning to smart meters by the end of 2022, which will eventually affect economic growth in Jordan.

## 4.5. Business Model and Opportunities for Smart Meters in Jordan

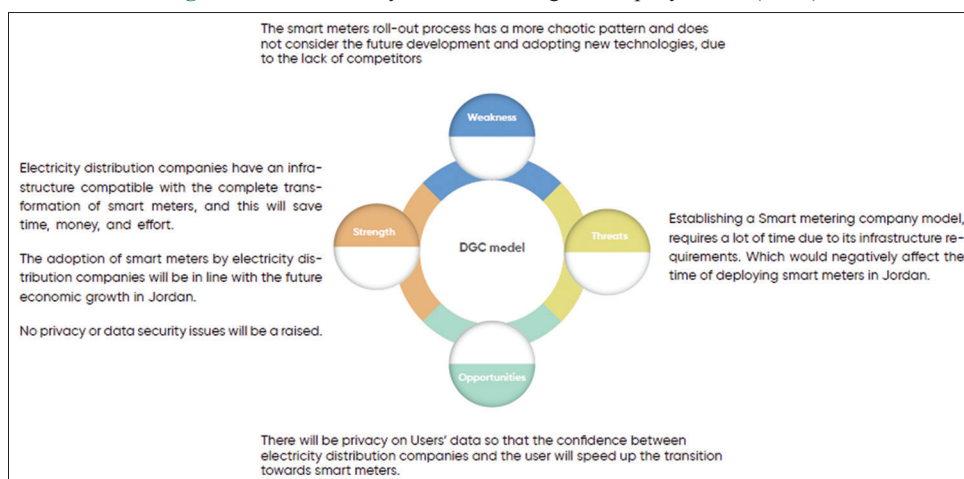
The current study has resulted with the following list of opportunities, in addition to the best fit business model for the electrical market in Jordan:

1. Smart metering is not the ultimate goal, but a tool for transitioning towards smart grids and dynamic tariffs (i.e., time-of-use tariff). The installation of smart meters has become a necessity to change the consumption behavior of electricity, improve grid management and security, encourage energy saving, manage and reduce the cost of electricity, control consumption and supply, facilitate the collection of bill fees, and integrate energy storage systems, not to mention the great impact this step will have on economic development.
2. In cooperation with the MEMR, electricity distribution companies, and the EMRC are working on the technical specifications and requirements of the smart meter transition in Jordan. This would lay a solid foundation aligned with the digital transformation in the energy sector.
3. The GPS communication method for smart meters is costly, but the cost can be reduced by using a combination of innovative solutions such as the programmable logic controller (PLC), data collectors, and GPS; as the cost of communications using the GPS system alone amounts to JOD 0.17 per month.
4. It is necessary to form a committee comprising all stakeholders, including telecommunication companies, electricity companies, private sector companies, legislators and decision makers. This committee will be tasked with developing a comprehensive action plan to accelerate shifting to smart metering, eventually paving the way for innovation and digital transformation in the energy sector. Not only will this step benefit all parties and create investment opportunities in other areas such as smart grids and the liberalization of the energy market in Jordan, but it will also foster investments and competitiveness in the energy market.
5. In cooperation with the World Bank, MEMR is developing a roadmap for digital transformation in the energy sector, and smart meters constitute a cornerstone in this transformation.

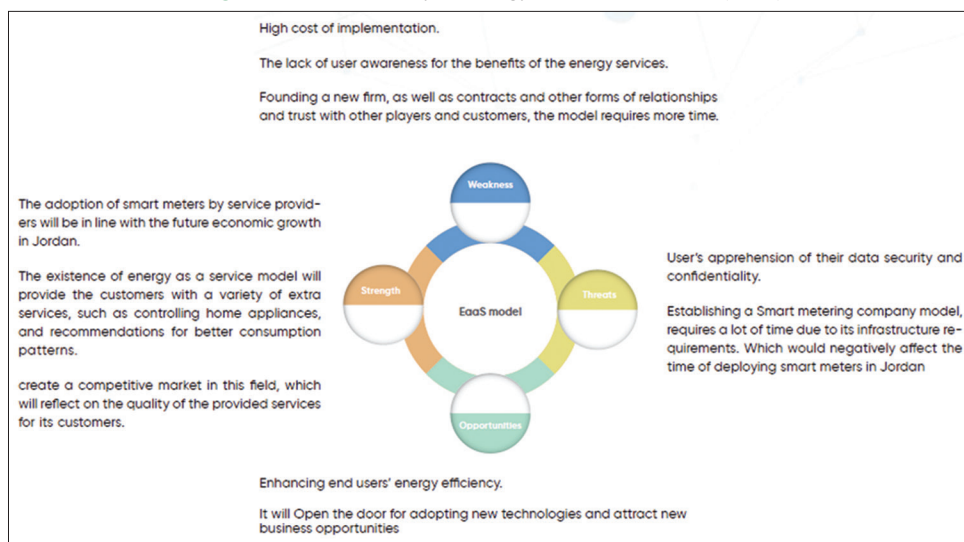
**Figure 17: SWOT analysis metering company model (MC)**



**Figure 18: SWOT analysis distribution grid company model (DGC)**



**Figure 19: SWOT analysis energy as a service model (EaaS)**



6. There is a new prevailing opportunity for distribution companies arising from the contract concluded between JEPSCO and a

specialized European consulting firm. The contract entails conducting a review of the technical specifications and the

delivery plan developed by JEPSCO, seeking to leverage the expertise of electric companies in developed countries where similar projects have been implemented. Not only will this step maximize the return on investments intended for this purpose and ensure the adoption of international best practices in the areas of billing, but it will also improve network planning, enhance load management, help detect tampering cases, save costs, and reduce receivables.

7. Renewable energy sources can be better utilized and managed by identifying consumption patterns and increasing the share of renewable energy in electricity networks.
8. Load shifting constitutes a great opportunity to better adjust demand in line with generation. In other words, load shifting is a measure to adjust electrical load by shifting consumption from peak demand hours of the day to off-peak periods.
9. Smart meters that apply a dynamic tariff contribute to improving grid management and flexibility, while flexibility is mainly achieved through energy storage and demand response. Therefore, the integration of renewable energy can only take place by ensuring grid flexibility; this is, switching to a smart grid.
10. The deployment of smart meters reduces electrical losses, whether technical losses or illegal electricity extraction, eventually saving financial costs and yielding returns to both electricity companies and consumers.
11. Smart meter deployment will pave the way for the technology market, including Internet of Things (IoT) sensors, big data management, and embedded AI. This will help maintain the safety, resilience, and security of energy grids amid the ongoing growth of decentralized power generation, electrical vehicles (EVs), storage, and expanded customer participation options.
12. Local factories should be established for manufacturing smart meter devices in Jordan, which will be the first of their kind in the region, ultimately enabling regional export. Such factories will also foster a high level of competition, as each distribution company can customize its own smart meters at very high standards.
13. Smart meters deployment will pave the way for transitioning into renewable energy in Jordan, requiring the endorsement of policies and incentives in this phase. With the dynamic tariff, smart meters would positively contribute to increasing the share of renewable energy.
14. The installation of smart meters with dynamic tariff will also lead to energy cost savings, as consumption will be shifted to cheaper time-of-use tariff. Such a saving in generation cost can be accomplished through higher shares of renewable energy in the energy generation mix. Therefore, the reduction of peak load and the increased distributed generation driven by the installation and management of smart meters would lead to grid investment and cost savings.
15. It is necessary to consider the end-of-life management of older meters and in-home energy displays (IHDs), including finding means of repurposing and recycling these products at the end of their lifecycle instead of their disposal.
16. The Distribution Grid Companies (DGC) model is the best business model that fits the Jordanian market. Although this model is currently applied in the Jordanian market, the Energy

as a Service (EaaS) business model is also needed, which can be combined with the DGC model as a hybrid model.

17. EaaS will assist in data monetization, forecasting, and trends since distribution companies lack the necessary expertise in this field. Hence, the need arises for adopting EaaS model in the concerned companies such as telecommunication companies.
18. Companies in the energy sector can use smart meter data along with underlying communication systems and technologies to:
  - i) Provide customers with innovative services, bill relief programs, and flexible customer payment plans;
  - ii) Effectively engage customers in programs to adjust their energy usage to meet clean energy goals;
19. Enhance energy grid resiliency and operations during extreme weather conditions.

Smart meters data will enable IT and telecommunication companies to provide software application service for those who installed smart meters. Many services can be provided by smart meter software application, such as:

- i) Tracking Energy Usage: Customers can better track the whole-home energy usage and detect energy spikes;
- ii) Tracking Energy Budget: Enabling customers to keep tabs on their energy spending by providing budget tracking;
- iii) Switching to Smart Homes for Better Energy Management: More customers will be able connect smart devices like thermostats, smart plugs, and smart light bulbs;
- iv) Engaging with the Energy Advisor: Customers can receive personalized advice to detect and avoid energy waste through the Energy Advisor, especially for industries with costly energy bills and environmental concerns. In parallel with the Energy Advisory, smart meters will support time-efficient and cost-effective measures, leading to lower production costs; and
- v) Spotting Power Saving Habits: Customers can track the habits and actions that drive energy efficiency.

#### 4.6. Smart Meters Rollout Challenges in Jordan

The challenges facing smart meters' rollout in Jordan can be summarized in the following points:

1. Lacking the necessary legislation, policies, bylaws, and a comprehensive transition plan developed by MEMR and EMRC, leading to low deployment of smart meters that fall behind the targeted percentage set out in the Energy Sector Strategy (ESS). Moreover, the distribution companies took the responsibility of installing smart meters without legislation by the EMRC, leading to increased costs of installing smart meters.
2. Lacking the capital funds that distribution companies require for setting up smart meters, posing a challenge for completing the rollout in line with the government target.
3. The shortage of human resources in utilities to install smart meters for all customers, posing a challenge for the full deployment of smart meters in 2022 in line with the government target.
4. Lack of trust in the management of private companies among customers, who believe the DGC would achieve better data security, which necessitates ensuring data privacy and security.



5. The high costs of taxes and customs as well as the procedures imposed on telecommunication companies and smart meter imports, which hinder the speed of transitioning to smart metering.
6. The necessity of enhancing the operational, technical, and business capabilities of distribution companies in Jordan in order to address the various challenges arising during the installation stages of smart metering systems.
7. The need for conducting further studies to address the impact of smart metering system on operators, distribution companies, and end-user prices, in addition to investigating the expected impact on the load profile and grid flexibility.
8. Lacking technical and evaluation studies that tackle the implementation of smart metering system in Jordan in particular and developing countries in general. Since smart meters are aimed at enabling a dynamic tariff that depends on the time of use, this tariff system would directly affect not only the end-user price, but also the economics of the energy market. It will also have social consequences on the consumption patterns, awareness, and further aspects of engagement with the billing system, but at the same time, smart metering will improve the infrastructure towards a smart grid.
9. Lack of public awareness of the smart meter transition and its benefits among the people in Jordan.

## 5. CONCLUSIONS AND RECOMMENDATIONS

### 5.1. Conclusions

The Energy Sector Strategy (ESS) which aims to install smart meters within the next three years –since its’ establishment-, 30% by 2020 and 30% by 2021, and 40% by 2022 seems to be not achieved. This is because of the COVID-19 pandemic, the lack of funds, and the need for further technical studies. Based on the collected data of the smart meters’ deployment via the electrical distribution companies, it is concluded that the current deployment of smart meters in the Jordanian market is around 10% by the end of 2021, which is too far from 1<sup>st</sup> year target in ESS.

In the current study, interviews with key stakeholders and a comprehensive survey has been prepared and distributed to energy sector stakeholders, policy makers, and experts. Based on the background review and results of the survey and interviews, a list of challenges, opportunities, and recommendations have been concluded.

Smart metering saves operational costs of bills, overhead cost and operation costs. Smart Meters transition reflects great impact in the distribution network, as for the consumers it enhances the quality of the service, readings sent automatically, improve interaction and awareness on consumption behaviors and measures. For operators and power providers it remotes reading and reduce the capital on manual readings and enable dynamic tariff. In addition, it brings benefits to the market as it enables open market multi-supplier business models and regards data security secure data communications. Also, smart meters will contribute in achieving

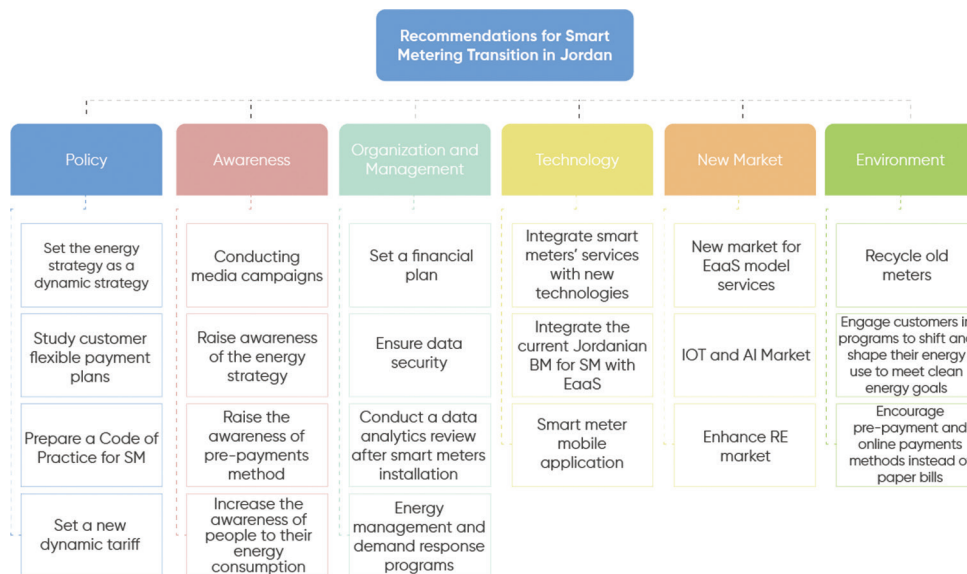
the increase the renewable energy share from 20% in 2020 to 31% in 2030, this target will contribute to the green economy.

It has been found that the best BM that fits the Jordanian context is a hybrid model that consists of the DGC and EaaS business models. As DGC business model will provide a privacy on Users data and has an infrastructure compatible with the complete transformation of smart meters, and this will save time, money and efforts. Also, the results show that the EMRC has to play its vital role as a monitoring utility to supervise the smart meters’ transition process.

### 5.2. Recommendations

Based on the aforementioned, this paper recommends the following course of actions:

1. Involve energy sector stakeholders (e.g. ministries, electrical distribution companies, IT companies, end-user private sector stakeholders such as factories and businesses with high electricity consumption, decision makers, etc.) in setting future strategies. The significance of such a step stems from the high influence these stakeholders have on achieving the strategy targets across the following aspects:
  - Policies and legislation (ministries);
  - Social aspects and service provision capabilities (distribution companies and telecommunication companies);
  - Costs and funding (financing companies); and
  - Demand and consumption (industries and private sector stakeholders).
2. Review the national laws and regulations in order to apply smart metering transition and plan for further expansion.
3. Ensure that the specifications of smart meters set by the EMRC are compatible with the smart meters already installed by distribution companies and capable of adopting the dynamic tariff in the near future.
4. Help minimize the delay in implementing the full transition to smart meters as per the ESS targets by developing an action plan for full smart meters transition in Jordan with new year target instead 2022. The new targets shall take into account assessing the current infrastructure, examining the capability to shift into smart meters, and determining the team capacity in alignment with the action plan.
5. Develop a strategy for enacting policies for digital transformation in the field of electricity and other related fields. The strategy must include targeted stakeholders with the support of the Ministry of Energy and Mineral Resources (MEMR), Energy & Minerals Regulatory Commission (EMRC), the Ministry of Digital Economy and Entrepreneurship (MODEE), and the Ministry of Planning & International Cooperation (MoP).
6. Set a financial plan that allocates the costs of installing smart meters to the different parties involved in this transition (i.e., electrical distribution companies, telecommunication companies, and financing companies).
7. Conduct a preliminary cost-benefit analysis (CBA analysis) for the smart meters’ transition in Jordan, while considering the future development of the industry. Research centers, energy researchers and experts in Jordan can undertake this role.

**Figure 20:** Recommendations for smart metering transition in Jordan

8. Leverage and scale up available opportunities to reduce time, efforts, and costs, such as adopting a meter data management (MDM) system for smart meters similar to the one already used by IDECO. This would ensure the alignment of smart meter operations with the various specifications.
9. Facilitate partnerships between electricity distribution companies and telecommunication companies with respect to smart meter data storage and security to save operational and infrastructure costs. The EMRC shall facilitate such partnerships given its key role in regulating and enhancing the energy sector.
10. Conduct further feasibility studies on smart meters to ensure infrastructure resilience, in addition to raising public awareness about the replacement of old meters with new smart meters by showing the additional features and the different billing system.
11. Prepare a Code of Practice after the installation of smart metering to safeguard consumer rights when using smart meters. The "Smart Metering Installation Code of Practice" must stipulate that consumers are entitled to receive the highest standard of service from the smart meter installation stage until the usage stage. Distribution companies should also educate consumers about the way of using the new metering system to rationalize their energy consumption.
12. Support energy consumption analysis to increase customers' awareness of their energy consumption, eventually encouraging the transition to smart meters among other customers. Following the installation of smart meters, it is recommended to collect and analyze data to help study consumer behaviors, consumption threshold, and usage trends.

Finally, the main recommendations for smart metering transition in Jordan have been listed in Figure 20.

## ACKNOWLEDGMENTS

We, EDAMA Association for Energy, Water and Environment, Mechanical Engineering Department of the University of Jordan,

and Architectural Engineering Department of the University of Jordan, acknowledge financial support for the article processing charge by Center for International Privat Enterprise (CIPE) within the funding programme. In addition, authors would like to thank all members of EDAMA Association, experts from the public and private sector, and anyone who participated in this paper.

## REFERENCES

- Azzuni, A., Aghahosseini, A., Ram, M., Bogdanov, D., Caldera, U., Breyer, C. (2020), Energy security analysis for a 100% renewable energy transition in Jordan by 2050. *Sustainability*, 12(12), 4921.
- Daminov, I., Tarasova, E., Andreeva, T., Avazov, A. (2016), Comparative analysis of smart meters deployment business models on the example of the Russian federation markets. *EPJ Web of Conferences*, 110, 01015.
- Dempsey, G. (2020), The Role of Smart Meters in Utilities GeoPal Solutions. Available from: <https://www.geopal.com/role-smart-meters-utilities> [Last accessed on 2021 Oct 10].
- DEWA. (2020), Sustainability Report 2020. Available from: <https://www.dewa.gov.ae/~media/Files/Customer/Sustainability%20Reports/DEWA%20Sustainability%20Report%202020%2015.ashx> [Last accessed on 2021 Oct 23].
- EDCO (2020) Annual Report of 2020. Maryland: EDCO. Available from: [https://www.edco.jo/images/Gallery1/Annual\\_Reports/Annual%20Report%20Electronic%202020.pdf](https://www.edco.jo/images/Gallery1/Annual_Reports/Annual%20Report%20Electronic%202020.pdf) [Last accessed on 2021 Aug 21].
- Edison Foundation. (2021), Electric Company Smart Meter Deployments: Foundation for a Smart Grid (2021 Update). Available from: [https://www.edisonfoundation.net/media/Files/IEI/publications/IEI\\_Smart\\_Meter\\_Report\\_April\\_2021.ashx](https://www.edisonfoundation.net/media/Files/IEI/publications/IEI_Smart_Meter_Report_April_2021.ashx) [Last accessed on 2021 Oct 23].
- Enemalta. (2017), What are the Different Types of Smart Meters? Enemalta. Available from: <https://www.enemalta.com.mt/uafaqs/different-types-smart-meters> [Last accessed 2021 Oct 10].
- Gandhi, K., Bansal, H.O. (2013), Smart Metering in electric power distribution system, in CARE 2013-2013. In: IEEE International Conference on Control, Automation, Robotics and Embedded Systems, Proceedings.
- Gordon, P. (2022), Saudi Arabia's AMI project progresses with 10 million smart meter rollout. Smart Energy International. Available from: <https://www.smart-energy.com/industry-sectors/energy-grid->

- management/saudi-arabias-ami-project-progresses-with-10-million-smart-meter-rollout [Last accessed on 2022 May 26].
- Grigoras, G. (2018), Impact of Smart Meter Implementation on Saving Electricity in Distribution Networks in Romania. In: Application of Smart Grid Technologies: Case Studies in Saving Electricity in Different Parts of the World. Amsterdam, Netherlands: Elsevier. p313-346.
- Insight, B. (2022), Europe replaces 50% of electricity meters with smart models. Renewable Energy World. Available from: <https://www.renewableenergyworld.com/energy-efficiency/europe-replaces-50-of-electricity-meters-with-smart-models/#gref> [Last accessed on 2022 May 26].
- JEPSCO. (2020), Smart Meters and Grids Project. Available from: <https://www.jepco.com.jo/ar/Home> [Last accessed on 2021 Aug 21].
- JEPSCO. (2021), Smart Meters and Grids Project. Available from: [Last accessed on 2022 May 26].
- KAPSARC. (2021), Beyond Smart Meters. Saudi Arabia: KAPSARC. Available from: <https://www.kapsarc.org/file-download.php?i=87318> [Last accessed on 2021 Oct 23].
- Martins, J.F. (2019), Smart Meters and Advanced Metering Infrastructure. In: Pathways to a Smarter Power System. Amsterdam, Netherlands: Elsevier. p89-114.
- MEMR. (2020), Jordanian National Strategy for Energy Sector 2020-2030. Available from: [https://www.memr.gov.jo/EBV4.0/Root\\_Storage/AR/EB\\_Info\\_Page/Strategy2020.pdf](https://www.memr.gov.jo/EBV4.0/Root_Storage/AR/EB_Info_Page/Strategy2020.pdf)
- Omdia. (2020), Smart Electricity Meters Break Through the 100 Million Units Per Year Barrier: London: Omdia. Available from: <https://omdia.tech.informa.com/OM003045/Smart-electricity-meters-break-through-the-100-million-units-per-year-barrier> [Last accessed 2021 Oct 10].
- Sandri, S., Hussein, H., Alshyab, N. (2020), Sustainability of the energy sector in Jordan: challenges and opportunities. Sustainability, 12(24), 10465.
- Šijaković, N., Kogalniceanu, V. (2020), Smart Grid Opportunities in the Energy Community Scoping Study. Available from: [https://www.energy-community.org/dam/jcr:c0c0049b-6cd1-4689-9bea-67e6e8c0b1ec/ECS\\_smartgrid\\_052020.pdf](https://www.energy-community.org/dam/jcr:c0c0049b-6cd1-4689-9bea-67e6e8c0b1ec/ECS_smartgrid_052020.pdf) [Last accessed on 2021 Oct 23].
- Smart Energy International. (2021). Available from: <https://www.smart-energy.com/industry-sectors/smart-meters/1-million-smart-meter-milestone-in-australia-and-new-zealand> [Last accessed on 2021 Oct 23].
- Telit. (2018), How to Leverage Smart Meter Opportunities with Future-Proof Designs. Irvine, California: Telit.
- UK Power Networks. (2015), Smart Meters and Losses: Best Practice Review. Available from: <https://www.ukpowernetworks.co.uk/losses/static/pdfs/smart-meters-and-losses-best-practice-review.bbbb974.pdf> [Last accessed on 2021 Oct 23].
- Umniah. (2019), Umniah Signs Agreement with Electricity Distribution Company to Supply Electrical Smart Meters. Available from: <https://www.umniah.com/en/explore-umniah/umniah-signs-agreement-with-electricity-distribution-company-to-supply-electrical-smart-meters> [Last accessed on 2021 Aug 15].
- Wiig, C., Operations, B.D.D. (2019), Smart Meters and Advanced Metering Infrastructure (AMI). Available from: <https://www.dnv.com/services/smart-meters-and-advanced-metering-infrastructure-6831> [Last accessed on 2021 Oct 10].